

OBSOLETE

Operating instructions

Pressure switch, heavy-duty version
TPST
Model PSM-530

EN



WIKAI

Part of your business

Contents

1. General information
2. Design and function
3. Safety
4. Transport, packaging and storage
5. Commissioning, operation
6. Faults
7. Maintenance and cleaning
8. Dismounting, return and disposal
9. Specifications

Declarations of conformity can be found online at www.wika.com.

© 07/2018 WIKA Alexander Wiegand SE & Co. KG
All rights reserved.
WIKA® is a registered trademark in various countries.

Prior to starting any work, read the operating instructions!
Keep for later use!

WIKA Alexander Wiegand SE & Co. KG
Alexander-Wiegand-Straße 30
63911 Klingenberg • Germany
Tel. +49 9372 132-0
Fax +49 9372 132-406
info@wika.de
www.wika.de

1. General information

- The mechanical pressure switch described in the operating instructions has been designed and manufactured using state-of-the-art technology. All components are subject to stringent quality and environmental criteria during production. Our management systems are certified to ISO 9001 and ISO 14001.
- These operating instructions contain important information on handling the instrument. Working safely requires that all safety instructions and work instructions are observed.
- Observe the relevant local accident prevention regulations and general safety regulations for the instrument's range of use.
- The operating instructions are part of the product and must be kept in the immediate vicinity of the pressure measuring instrument and readily accessible to skilled personnel at any time.
- Skilled personnel must have carefully read and understood the operating instructions prior to beginning any work.
- The manufacturer's liability is void in the case of any damage caused by using the product contrary to its intended use, non-compliance with these operating instructions, assignment of insufficiently qualified skilled personnel or unauthorised modifications to the instrument.
- The general terms and conditions contained in the sales documentation shall apply.
- Subject to technical modifications.
- Further information:
 - Internet address: www.wika.de / www.wika.com
 - Relevant data sheet: PV 35.02

Abbreviations, definitions

TPST 3-pole normally closed/normally open

DPST 2-pole normally closed/normally open

SPST 1-pole normally closed/normally open

NC Normally closed contact type (NC) is closed at atmospheric pressure

NO Normally open contact type (NO) is open at atmospheric pressure

COM Common contact

GND Ground connection

MS Motor protection

2. Design and function

2.1 Overview

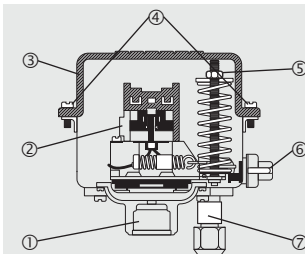

- ① Process connection
- ② TPST switch contact
- ③ Removable plastic cover
- ④ 2 mounting screws for plastic cover
- ⑤ Switch point setting
- ⑥ Manual On/Off switch (optional without)
- ⑦ Option: Relief valve

2.2 Description

The pressure element of the model PSM-530 is a diaphragm from NBR which works against a spring mechanism with an adjustable pre-load force. On the spring mechanism there is a contact arm for actuating the TPST switch contact. The switch is actuated as soon as the force generated by the pressure in the pressure element is greater than the set pre-load force. With the manual On/Off switch, the contact system can be locked in the open position, irrespective of the process pressure.

The optionally mounted relief valve is used, e.g. in a compressor application, for venting the pressure chamber of the compression piston before starting the motor.

2.3 Terms used

Maximum operating pressure

The maximum static pressure with which the instrument can be used without changing the assured performance data, such as the non-repeatability of the switch point.

Reset point

The pressure value at which the switch returns to the starting position. Mathematically, the pressure value for the reset point is equal to the pressure value of the switch point minus the switch differential on rising pressure. On falling pressure, the pressure value for the reset point is equal to the pressure value of the switch point plus the switch differential.

Switch differential

The switch differential is the difference between the switch point and the reset point. This is also known as the switch hysteresis.

2.4 Scope of delivery

Pressure switch, operating instructions

Cross-check scope of delivery with delivery note.

3. Safety

3.1 Explanation of symbols



WARNING!

... indicates a potentially dangerous situation that can result in serious injury or death, if not avoided.



CAUTION!

... indicates a potentially dangerous situation that can result in light injuries or damage to property or the environment, if not avoided.



DANGER!

... identifies hazards caused by electrical power. Should the safety instructions not be observed, there is a risk of serious or fatal injury.



WARNING!

... indicates a potentially dangerous situation that can result in burns, caused by hot surfaces or liquids, if not avoided.



Information

... points out useful tips, recommendations and information for efficient and trouble-free operation.

3.2 Intended use

The model PSM-530 mechanical pressure switch is fitted with a TPST switch contact and is used in industrial control, monitoring and alarm applications. The switch point can be specified by the customer on site. The instrument can switch electrical loads of up to AC 440 V, 9 A.

The PSM-530 pressure switch offers many application possibilities with non-corrosive media like oil, water and air.

Only use the instrument in applications that lie within its technical performance limits (e.g. max. ambient temperature, material compatibility, ...).

→ For performance limits see chapter 9 "Specifications".

This instrument is not permitted to be used in hazardous areas!

The instrument has been designed and built solely for the intended use described here, and may only be used accordingly.

The manufacturer shall not be liable for claims of any type based on operation contrary to the intended use.

3.3 Improper use



WARNING!

Injuries through improper use

Improper use of the instrument can lead to hazardous situations and injuries.

- ▶ Refrain from unauthorised modifications to the instrument.
- ▶ Do not use the instrument within hazardous areas.
- ▶ Do not use the instrument with abrasive or highly viscous media.

Any use beyond or different to the intended use is considered as improper use.

3.4 Personnel qualification



WARNING!

Risk of injury should qualification be insufficient!

- Improper handling can result in considerable injury and damage to equipment.
- ▶ The activities described in these operating instructions may only be carried out by skilled personnel who have the qualifications described below.

Skilled electrical personnel

Skilled electrical personnel are understood to be personnel who, based on their technical training, know-how and experience as well as their knowledge of country-specific regulations, current standards and directives, are capable of carrying out work on electrical systems and independently recognising and avoiding potential hazards. The skilled electrical personnel have been specifically trained for the work environment they are working in and know the relevant standards and regulations. The skilled electrical personnel must comply with current legal accident prevention regulations.

3.5 Labelling, safety marks

Product label

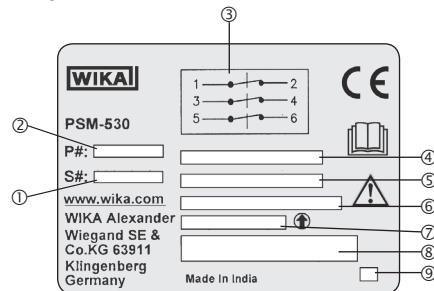

- ① Serial number
- ② Article number
- ③ Pin assignment
- ④ Setting range
- ⑤ Adjustable switch differential
- ⑥ Type of contact
- ⑦ Switch point
- ⑧ Electrical rating
- ⑨ Coded date of manufacture



Before mounting and commissioning the instrument, ensure you read the operating instructions!

4. Transport, packaging and storage

4.1 Transport

Check the instrument for any damage that may have been caused by transport. Obvious damage must be reported immediately.



CAUTION!

Damage through improper transport

With improper transport, a high level of damage to property can occur.

- ▶ When unloading packed goods upon delivery as well as during internal transport, proceed carefully and observe the symbols on the packaging.
- ▶ With internal transport, observe the instructions in chapter 4.2 "Packaging and storage".

If the instrument is transported from a cold into a warm environment, the formation of condensation may result in instrument malfunction. Before putting it back into operation, wait for the instrument temperature and the room temperature to equalise.

4.2 Packaging and storage

Do not remove packaging until just before mounting.

Keep the packaging as it will provide optimum protection during transport (e.g. change in installation site, sending for repair).

Permissible conditions at the place of storage:

- Storage temperature: -20 ... +80 °C (-4 ... +176 °F)
- Humidity: 35 ... 85 % relative humidity (no condensation)

Avoid exposure to the following factors:

- Direct sunlight or proximity to hot objects
- Mechanical vibration, mechanical shock (putting it down hard)
- Soot, vapour, dust and corrosive gases
- Hazardous environments, flammable atmospheres

Store the instrument in its original packaging in a location that fulfils the conditions listed above.

5. Commissioning, operation

Before installation, commissioning and operation, ensure that the appropriate instrument has been selected in terms of design and specific measuring conditions.

Tools: Cross-head screwdriver, slotted screwdriver, 8 mm open-ended spanner or 8 mm socket wrench

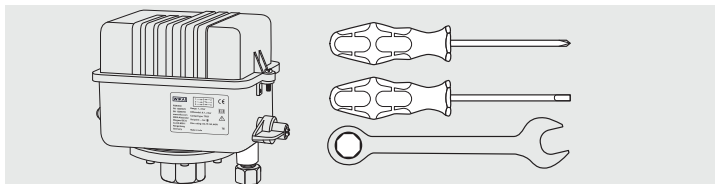

5.1 Requirements at the measuring point

- The process pressure must not exceed the specified maximum operating pressure.
- Permissible ambient and medium temperatures remain within the performance limits.
- Protected from weather influences.
- Any vibrations or shocks which occur must not exceed accelerations of 1 g (9.81 m/s²) within a frequency range of 10 ... 150 Hz.
- Sealing faces are clean and undamaged.
- Sufficient space for a safe electrical installation.

→ For performance limits see chapter 9 "Specifications"

5.2 Mechanical mounting

- After unpacking the instrument, a visual inspection for damage must be carried out.
- Mounting is only permitted in the depressurised state. Reliably depressurise the instrument using the available valves and protective devices.
- Use seals suitable for the process connection provided.
- When screwing the instruments in, the force required for sealing must not be applied through the case, but only through the spanner flats provided for this purpose on the process connection, and using a suitable tool. The tightening torque is dependent on the selected process connection.

5.3 Presetting of switch differential

1. Remove 2 screws with the cross-head screwdriver and open plastic cover

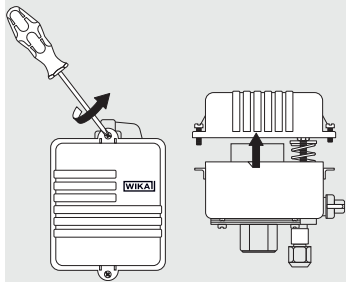

2. Turn the switch differential screw anticlockwise with the slotted screwdriver until the spring is free from tension

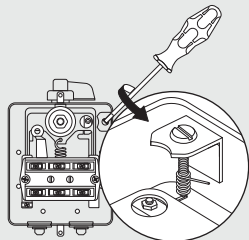

Clamping the cable

1. Remove the rubber grommets (2 pieces) and match them to the cable diameter
2. Insert the rubber grommets and route the cable as shown

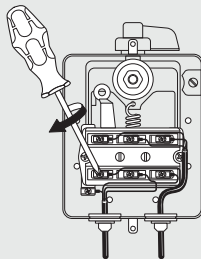

3. Power supply: 3-phase alternating current
Carry out the terminal assignment according to the switching function, max. tightening torque: 1.8 Nm (16 lbf in)

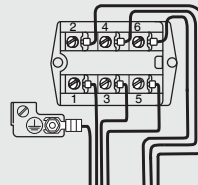

- | | | |
|---|-----|---------------------------------|
| 1 | NC | Normally closed 1, power supply |
| 2 | NC | Normally closed 1, load |
| 3 | NC | Normally closed 2, power supply |
| 4 | NC | Normally closed 2, load |
| 5 | NC | Normally closed 3, power supply |
| 6 | NC | Normally closed 3, load |
| ⊕ | GND | Ground connection |

5.4 Electrical mounting

Integration of the pressure switch into the installation

Depending on the load characteristics, additional protective measures, e.g. for motor protection, may be required.



DANGER!

Danger to life caused by electric current

Upon contact with live parts, there is a direct danger to life.

- ▶ The instrument may only be installed and mounted by skilled personnel.

Switch off the load circuit before starting work and secure against being switched on unauthorised.

Cable preparation

Size the connecting cables for the largest current strength in the circuits and ensure sufficient UV resistance and mechanical stability.

Recommendation: 4-wire cable with conductor cross-section of 1.5 mm², max. outer Ø 14 mm. Wire ends fitted with spade lugs.

Grounding

Include the ground connection in the inside of the instrument into the grounding concept of the installation.

Power supply: 1-phase alternating current

The model PSM-530 can be integrated into the installation for loads with 1-phase alternating current, as shown below.

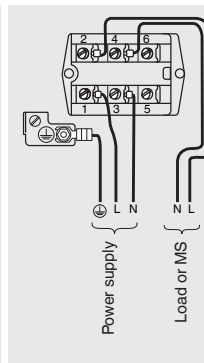
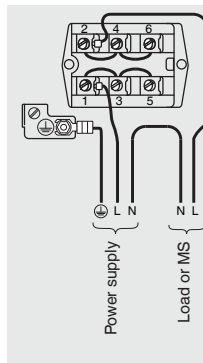
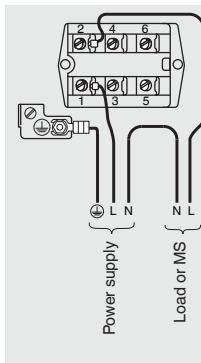

5.5 Switch point setting

For an exact setting of the switch point, a test assembly with pressure generation and pressure reference is needed. This test assembly can, for example, be realised with a model CPG1500 precision digital pressure gauge and a model CPP30 hand test pump (not shown).

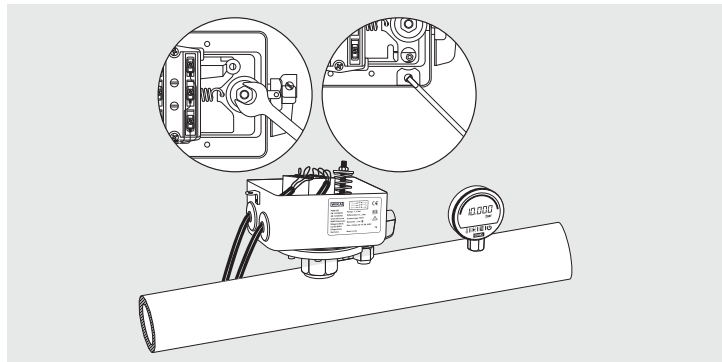

1. Connect the model PSM-530 pressure switch, pressure reference and pressure generation to a common pressure system.
2. Ensure that the switch point setting does not switch any loads on or off by mistake. For visualisation of the switching function, an equivalent circuit, e.g. with a light bulb, is recommended.
3. Drive slowly towards the required switch point pressure with the pressure generation and pressure reference. Depending on the definition of the switch point, this must be carried out on rising/falling pressure.
 - If the instrument switches **before** the required switch point is reached, the switch point setting must be turned clockwise (+) with the open-ended spanner.
 - If the instrument switches **after** the required switch point is reached, the switch point setting must be turned anticlockwise (-) with the open-ended spanner.After each correction, release/build up the pressure and repeat this procedure until the switch point is set correctly.
4. Release/build up the pressure slowly and check the reset point.
 - If the pressure value of the reset point is **too high**, the adjustment screw for the switch differential must be turned clockwise with the slotted screwdriver.
 - If the pressure value of the reset point is **too low**, the adjustment screw for the switch differential must be turned anticlockwise with the slotted screwdriver.After correcting the switch differential, the switch point must be re-checked. Carry out step 3 again.

5. If the switch point and the reset point coincide with the required pressure values, the switch point setting is complete.
6. Close the plastic cover again and fix it with the 2 screws, see chapter 2.1 "Overview".

The switch point setting must be checked after 3 months.

6. Faults



CAUTION!

Physical injuries and damage to property and the environment

If faults cannot be eliminated by means of the listed measures, the instrument must be taken out of operation immediately.

- ▶ Ensure that there is no pressure in the instrument and that the load circuit is switched off. Protect against being put into operation accidentally.
- ▶ Contact the manufacturer.
- ▶ If a return is needed, please follow the instructions given in chapter 8.2 "Return".



WARNING!

Physical injuries and damage to property and the environment caused by media

Upon contact with hazardous media, harmful media (e.g. corrosive, toxic, carcinogenic), and also with refrigeration plants and compressors, there is a danger of physical injuries and damage to property and the environment. Should a failure occur, aggressive media with extremely high temperature and under high pressure or vacuum may be present at the instrument.

- ▶ For these media, in addition to all standard regulations, the appropriate existing codes or regulations must also be followed.



For contact details see chapter 1 "General information".

Faults	Causes	Measures
Contact is not switching in accordance with the specification at the set switch point/reset point	Electrical connection is interrupted.	Carry out a continuity test on the electrical connection lines.
	Wiring error, e.g. short circuit	Check the pin assignment and correct it if necessary
	Electrical load unsuitable.	Maintain the permissible electrical loads.
	Contact contaminated.	Replace instrument
	Switch differential greater than the switch point.	Carry out switch point setting with matching test assembly, see chapter 5.5.
	Vibrations	Decouple the instrument mechanically. Permissible vibrations, see chapter 5.5.
Manual switch in Off position.	Turn the manual switch to On position.	
Short circuit	Moisture in the instrument.	Only use in ambient conditions for which the ingress protection is suitable.
Contact chatter (repeated, short-duration opening and closing).	Vibrations	Decouple the instrument mechanically. Permissible vibrations, see chapter 5.5.
Switching status remains unchanged despite reaching the switch point/reset point.	Error with switch point setting.	Carry out switch point setting with matching test assembly, see chapter 5.5.
	Contacts defective (e.g. fused contact zone).	Replace instrument Before recommissioning the new instrument, provide a protective circuit for the contact.
	Pressure port blocked.	Replace instrument
	Leakage	Carry out a leak test. Seal the process connection or replace the instrument.
Relief valve is not working	Pressure port blocked.	Replace instrument

For the exchange of the instrument chapters 8 "Dismounting, return and disposal" and 5 "Commissioning, operation" must be observed.

7. Maintenance and cleaning

7.1 Maintenance

The instruments are maintenance-free.

The switch point setting must be checked after 3 months. Carry out switch point setting with matching test assembly, see chapter 5.5.

Repairs must only be carried out by the manufacturer.

7.2 Cleaning



CAUTION!

Physical injuries and damage to property and the environment

Improper cleaning may lead to physical injuries and damage to property and the environment. Residual media in the dismantled instrument can result in a risk to persons, the environment and equipment.

► Carry out the cleaning process as described below.

1. Before cleaning, correctly disconnect the instrument from the pressure supply and switch the load circuit off.
2. Use the requisite protective equipment.
3. Clean the instrument with a moist cloth.
Electrical connections must not come into contact with moisture!



CAUTION!

Damage to the instrument

Improper cleaning may lead to damage to the instrument!

- Do not use any aggressive cleaning agents.
- Do not use any hard or pointed objects for cleaning.

4. Wash or clean the dismantled instrument, in order to protect persons and the environment from exposure to residual media.

8. Dismounting, return and disposal



WARNING!

Physical injuries and damage to property and the environment through residual media

Residual media in the dismantled instrument can result in a risk to persons, the environment and equipment.

- Observe the information in the material safety data sheet for the corresponding medium.
- Wash or clean the dismantled instrument, in order to protect persons and the environment from exposure to residual media.

8.1 Dismounting



WARNING! Risk of burns

During dismounting there is a risk of dangerously hot media escaping.

- ▶ Let the instrument cool down sufficiently before dismounting it!



DANGER! Danger to life caused by electric current

Upon contact with live parts, there is a direct danger to life.

- ▶ The dismounting of the instrument may only be carried out by skilled personnel.
- ▶ Remove the instrument once the system has been isolated from power sources.



WARNING! Physical injury

When dismounting, there is a danger from aggressive media and high pressures.

- ▶ Observe the information in the material safety data sheet for the corresponding medium.
- ▶ Dismount the instrument when there is no pressure.

8.2 Return

Strictly observe the following when shipping the instrument:
All instruments delivered to WIKA must be free from any kind of hazardous substances (acids, bases, solutions, etc.) and must therefore be cleaned before being returned.



WARNING! Physical injuries and damage to property and the environment through residual media

Residual media in the dismantled instrument can result in a risk to persons, the environment and equipment.

- ▶ With hazardous substances, include the material safety data sheet for the corresponding medium.
- ▶ Clean the instrument, see chapter 8.2 "Cleaning".

When returning the instrument, use the original packaging or a suitable transport packaging.

8.3 Disposal

Incorrect disposal can put the environment at risk.
Dispose of instrument components and packaging materials in an environmentally compatible way and in accordance with the country-specific waste disposal regulations.

9. Specifications

Operating conditions

Permissible temperature ranges
Ambient: -40 ... +70 °C (-40 ... +158 °F)
Medium: -20 ... +70 °C (-4 ... +158 °F)
Storage: -20 ... +80 °C (-4 ... +176 °F)

Reference conditions

Relative humidity per BS 6134
< 50 % r. h. at 40 °C (104 °F)
< 90 % r. h. at 20 °C (68 °F)

Ingress protection per IEC/EN 60529 IP44

Non-repeatability of the switch point ≤ 2 % of span

Switch contact

3-pole normally closed / TPST
Can also be used as 2-pole normally closed / DPST or 1-pole normally closed / SPST.

Electrical rating

Current consumption ¹⁾	Voltage	Current
Inductive load, AC-15	AC 230 V / AC 440 V	9 A

1) per DIN EN 60947-1

Permissible switch points and switch differential

Unit	Setting range ¹⁾	Permissible switch point on rising pressure	Adjustable switch differential ²⁾	Max. operating pressure
bar	1 ... 4	1.7 ... 4	0.7 ... 3	8
	2.5 ... 9.5	4.3 ... 9.5	1.8 ... 7	20
	7 ... 15	9.3 ... 15	2.3 ... 7	20
MPa	0.1 ... 0.4	0.17 ... 0.4	0.07 ... 0.3	0.8
	0.25 ... 0.95	0.43 ... 0.95	0.18 ... 0.7	2
	0.7 ... 1.5	0.93 ... 1.5	0.23 ... 0.7	2

1) Switch point and reset point have to be within the setting range

2) The difference between the switch point and the reset point is also known as switch hysteresis

For further specifications see WIKA data sheet PV 35.02 and the order documentation.