

Pressure controller Modular version Model CPC6050

Applications

- Healthcare and avionics industry
- Industry (laboratory, workshop and production)
- Transmitter and pressure measuring instrument manufacturers
- Calibration service companies and service industry
- Research and development laboratories

Special features

- Pressure ranges: -1 ... 210 bar [-15 ... 3,045 psi]
- Control speed 15 s
- Control stability < 0.003 % FS
- Accuracy down to 0.008 % IS (IntelliScale)
- Precision 0.004 % FS

Description

Design

The highly configurable model CPC6050 modular pressure controller offers maximum flexibility to best suit the customers' requirements. The instrument can have up to two independent pressure regulating channels which can operate simultaneously. Each channel can have up to two transducers. The instrument can also have an optional barometric reference for gauge or absolute pressure emulation. This instrument can be specified as a desktop or as 19" rack-mounting kit.

Application

The controller offers many applications within calibration laboratories and production environments because of its pressure range -1 ... 210 bar [-15 ... 3,045 psi] and accuracy down to 0.008 % IS-33. Its ability to control minimum pressures such as 25 mbar [10 inH₂O] span with a high stability makes it the ideal calibration and verification solution for healthcare and aerospace industries.



Pressure controller, modular version, model CPC6050

Simultaneous calibration channels along with interchangeable plug-and-play pressure transducers and an intuitive GUI makes CPC6050 an easy-to-use and low-maintenance instrument.

Functionality

The touchscreen, along with an intuitive user interface, provide maximum ease-of-use. The large number of menu languages add to its operability. In addition to specifying a certain pressure set point, either by entering it via touchscreen or sending it via remote interface, the pressure can be changed in defined, programmable steps by using the STEP buttons.

Moreover, the user can also easily create extensive test programs using the instrument menu. Depending on the application, the rate of control can be either pre-set precision, high speed or a user-defined variable rate.

Software

The WIKA-Cal calibration software enables the convenient calibration of pressure measuring instruments and the generation of test certificates. The instrument can also be remotely controlled using either the Mensor standard, SCPI or other optional command sets.

Complete test and calibration systems

On request, complete mobile or stationary test systems can be manufactured. There is an IEEE-488.2, RS-232, USB and an Ethernet interface for communication with other instruments, and thus the instrument can be integrated into existing systems.

Backward compatibility

The highly configurable CPC6050 can also be used with model CPR6000 pressure transducers of its predecessor model CPC6000. The CPR6000 transducers can be used individually or together with the CPR6050, hence providing the user a complete backward capability.

Specifications

Reference pressure transducer model CPR6050			
Pressure range	Standard		
Accuracy ¹⁾	0.01 % FS ²⁾		
Gauge pressure ⁶⁾	0 ... 0.025 to 0 ... 210 bar [0 ... 0.36 to 0 ... 3,045 psi]		
Bidirectional pressure ⁶⁾	-0.012 ... +0.012 to -1 ... 210 bar [-0.18 ... +0.18 to -15 ... 3,045 psi]		
Absolute pressure ⁷⁾	0 ... 0.5 to 0 ... 211 bar abs. [0 ... 7.5 to 0 ... 3,060 psi abs.]		
Precision ⁸⁾	0.004 % FS		
Calibration interval	365 days ⁹⁾		
Pressure range	Optional		
Accuracy ¹⁾	0.008 % FS	<ul style="list-style-type: none"> ■ 0.008 % IS-50 ³⁾ ■ 0.01 % IS-50 ⁴⁾ 	0.008 % IS-33 ⁵⁾
Gauge pressure ⁶⁾	0 ... 0.025 to 0 ... 210 bar [0 ... 0.36 to 0 ... 3,045 psi]	0 ... 1 to 0 ... 210 bar [0 ... 15 to 0 ... 3,045 psi]	0 ... 1 to 0 ... 100 bar [0 ... 15 to 0 ... 1,500 psi]
Bidirectional pressure ⁶⁾	-0.012 ... +0.012 to -1 ... 210 bar [-0.18 ... +0.18 to -15 ... 3,045 psi]	-1 ... 10 to -1 ... 210 bar [-15 ... 145 to -15 ... 3,045 psi]	-1 ... 10 to -1 ... 100 bar [-15 ... 145 to -15 ... 1,500 psi]
Absolute pressure ⁷⁾	0 ... 0.5 to 0 ... 211 bar abs. [0 ... 7.5 to 0 ... 3,060 psi abs.]	0 ... 1 to 0 ... 211 bar abs. [0 ... 15 to 0 ... 3,060 psi abs.]	0 ... 1 to 0 ... 101 bar [0 ... 15 to 0 ... 1,515 psi]
Calibration interval	365 days	365 days	365 days
Precision ⁸⁾	0.004 % FS	0.004 % FS	0.004 % FS

1) It is defined by the total measurement uncertainty, with the coverage factor (k = 2) and includes the intrinsic performance of the instrument, the measurement uncertainty of the reference instrument, long-term stability, influence of ambient conditions, drift and temperature effects over the compensated range with recommended zero point adjustment every 30 days.

2) FS = Full span = end of measuring range - start of measuring range

3) 0.008 % IS-50 accuracy: Between 0 ... 50 % of the full scale, the accuracy is 0.008 % of the half full scale and between 50 ... 100 % of the full scale, the accuracy is 0.008 % of reading.

4) 0.01 % IS-50 accuracy: Between 0 ... 50 % of the full scale, the accuracy is 0.01 % of the half full scale and between 50 ... 100 % of the full scale, the accuracy is 0.01 % of reading.

5) 0.008 % IS-33 accuracy: Between 0 ... 33 % of the full scale, the accuracy is 0.008 % of the lower third of the full scale and between 33 ... 100 % of the full scale, the accuracy is 0.008 % of reading.

6) For pressure ranges from $\geq 100 \dots \leq 138$ bar [$\geq 1,500 \dots \leq 2,000$ psi] gauge will be sealed gauge sensors.

7) The minimum calibrated range of absolute transducer(s) is 600 mTorr.

8) It is defined as the combined effects of linearity, repeatability and hysteresis throughout the stated compensated temperature range.

9) 180 days for pressure ranges below 1 bar [14.5 psi] gauge or absolute, and -1 ... +1 bar [-15 ... +14.5 psi] bidirectional. 365 days for the remainder of the specified ranges.

Barometric reference, optional	
Measuring range	<ul style="list-style-type: none"> ■ 552 ... 1,172 mbar abs. ■ 8 ... 17 psi abs. ■ 552 ... 1,172 hPa abs.
Accuracy ¹⁾	0.01 % of reading
Function	The barometric reference can be used to switch pressure types ²⁾ , absolute <=> gauge. With gauge pressure transducers, the measuring range of the transducers must begin with -1 bar [-15 psi] in order to carry out a complete absolute pressure emulation.

- 1) It is defined by the total measurement uncertainty, with the coverage factor (k = 2) and includes the intrinsic performance of the instrument, the measurement uncertainty of the reference instrument, long-term stability, influence of ambient conditions, drift and temperature effects over the compensated range with recommended zero point adjustment every 30 days.
- 2) For a pressure type emulation, we recommend a native absolute pressure transducer, since the zero point drift can be eliminated through a zero point adjustment.

Pressure controller CPC6050	
Instrument	
Instrument version	<ul style="list-style-type: none"> ■ Desktop case ■ 19" rack-mounting kit
Dimensions	See technical drawings
Weight	Approx. 22.7 kg [50 lb] incl. all internal options
Warm-up time	Approx. 15 min
Digital display	
Type of display	10.1" colour LC display with capacitive touchscreen
Display resolution	4 ... 6 digits depending on range and units
Measuring range	-0.012 ... +0.012 to -1 ... 210 bar [-0.18 ... +0.18 to -15 ... 3,045 psi] Depending on the reference pressure transducer model CPR6050
Pressure type	<ul style="list-style-type: none"> ■ Gauge ■ Absolute ■ Bidirectional
Unit	39 and two freely programmable pressure units
Pressure limitation (vacuum and overpressure)	
Measure/Control port	100 % of the primary sensor range
Supply port	110 % of primary sensor range
Reference port	Atmosphere
Vent port	Atmosphere
Exhaust port	Ambient pressure down to full vacuum
Overpressure limit	
Measure/Control port	105 % of primary sensor range
Supply port	110 % of CPM range
Reference port	Atmosphere ±350 mbar [±5 psi]
Vent port	Atmosphere
Exhaust port	Full vacuum

Control parameter	SVR module ¹⁾	LPPump module
Control stability	< 0.003 % FS of the active range (typical 0.001 % FS ²⁾)	
Control mode	Precision, high speed and customised	External supply ON/OFF
Control speed	15 s ³⁾	25 s ³⁾
Control range	0 ... 100 % FS	
Minimum control pressure	0.0017 bar [0.025 psi] over exhaust pressure or 0.05 % FS whichever is greater	0.0034 bar [0.05 psi] over exhaust pressure or 0.05 % FS whichever is greater
Overshoots	< 1 % FS in high-speed control mode (typical < 0.05 % FS in precision control mode)	< 1 % FS in high-speed control mode (< 0.1 % FS in pump only mode)
Test volume	50 ... 1,000 ccm	50 ... 300 ccm

1) Represents LPSVR, MPSVR, HPSVR and EPSVR

2) Typical stability achieved 10 seconds after the stable indication, when controlling on pressure above atm.

3) Regarding a 10 % FS pressure increase above atmosphere in a 50 ml test volume, in high-speed control mode (SVR) or external supply on (LPPump)

Communication	
Interface	<ul style="list-style-type: none"> ■ Ethernet ■ IEEE-488 ■ USB ■ RS-232
Communication protocol	10/100Based-T
Baud rate	<ul style="list-style-type: none"> ■ 9600 ■ 19200 ■ 38400 ■ 57600 ■ 115200
Command sets	<ul style="list-style-type: none"> ■ Mensor ■ WIKA SCPI ■ Others on request
Response time	Approx. 100 ms
Measuring rate	30 ... 60 ms
Internal program	Up to 24 sequences with up to 99 steps each

Pressure connection on the CPC6050	
Connections	<ul style="list-style-type: none"> ■ Up to 8 ports with 7/16"- 20 F SAE ■ Up to 2 ports with 1/8" F NPT ■ 1 port with 10-32 UNF female
Filter elements	All pressure ports have 40-micron filters.
Pressure port adapters	<ul style="list-style-type: none"> ■ Without ■ 6 mm tube fitting ■ 1/4" tube fitting ■ 1/4 NPT, female thread ■ 1/8 NPT, female thread ■ 1/8 BSP, female thread
Barometer port adapters	<ul style="list-style-type: none"> ■ Barb fitting ■ 6 mm tube fitting ■ 1/4" tube fitting
Wetted parts	<ul style="list-style-type: none"> ■ Aluminium ■ Brass ■ Buna N ■ Urethane ■ FKM/FPM ■ PCTFE ■ PEEK ■ PTFE ■ PPS ■ RTV ■ Ceramic ■ Silicone ■ Silicone grease ■ Stainless steel 316 and 316L ■ Glass-filled epoxy
Overpressure protection	Safety relief valve fixed to reference pressure transducer and adjusted to customised measuring range

Voltage supply	
Operating voltage	<ul style="list-style-type: none"> ■ AC 100 ... 120 V, 50/60 Hz ■ AC 220 ... 240 V, 50/60 Hz
Power consumption	Max. 210 VA
Overvoltage resistance	Category II
Electrical safety	Protection class 1 (PE connected)
Fuse	1.6 A, 250 V; SLO-BLO 5 x 20 mm
Power cord	<ul style="list-style-type: none"> ■ For Europe ■ For USA/Canada ■ For UK ■ For India ■ For China

Operating conditions	
Altitude	Up to 3,048 m [10,000 ft] above sea level
Place of use	Indoor
Operating temperature	0 ... 50 °C [32 ... 122 °F]
Compensated temperature range	15 ... 45 °C [59 ... 113 °F]
Storage temperature range	-20 ... +70 °C [-4 ... +158 °F]
Relative humidity, condensation	5 ... 95 % r. h. (non-condensing)
Permissible media	<ul style="list-style-type: none"> ■ Dry, clean air ■ Nitrogen (ISO 8573-1:2010 class 5.5.4 or better)
Mounting position	Horizontal
EMC (HF field)	EN 61326-1 emission (group 1, class A) and immunity (industrial application)

Approvals

Logo	Description	Region
CE	EU declaration of conformity	European Union
	EMC directive ¹⁾ EN 61326-1 emission (group 1, class A) and immunity (industrial application)	
	Low voltage directive	
	RoHS directive	
UK CA	UKCA	United Kingdom
	Electromagnetic compatibility regulations	
	Electrical equipment designed for use within certain voltage limits in support of the electrical equipment (safety) regulations	
	Restriction of hazardous substances (RoHS) regulations	

1) **Warning!** This is class A equipment for emissions and is intended for use in industrial environments. In other environments, e.g. residential or commercial installations, it can interfere with other equipment under certain conditions. In such circumstances the operator is expected to take the appropriate measures.

Optional approvals

Logo	Description	Region
-	MChS Permission for commissioning	Kazakhstan

Certificates

Certificate	
Calibration ¹⁾	
Reference pressure transducer model CPR6050	<ul style="list-style-type: none"> ■ A2LA calibration certificate (traceable and accredited in accordance with ISO/IEC 17025) ■ DAkkS calibration certificate - gauge pressure (traceable and accredited in accordance with ISO/IEC 17025) ■ DAkkS calibration certificate - absolute pressure (traceable and accredited in accordance with ISO/IEC 17025)
Barometric reference	<ul style="list-style-type: none"> ■ Without ■ A2LA calibration certificate (traceable and accredited in accordance with ISO/IEC 17025) ■ DAkkS calibration certificate for barometric reference (traceable and accredited in accordance with ISO/IEC 17025)
Recommended calibration interval	1 year (dependent on conditions of use)

1) Calibration in a horizontal position / operating position.

Approvals and certificates, see website

Working ranges of the controller modules

Bidirectional or gauge pressure (bar [psi]) ¹⁾

-1 [-15]	0	1 [15]	3.4 [50]	10 [150]	100 [1,500]	210 [3,045]
LPPump MODULE ± 12.5 mbar [± 0.18 psi] ²⁾						
LPSVR MODULE ± 12.5 mbar [± 0.18 psi] ²⁾						
MPSVR MODULE ± 0.35 bar [± 5 psi] ²⁾						
HPSVR MODULE -1 ... 5 bar [-15 ... +75 psi] ²⁾						
EPSVR MODULE -1 ... 10 bar [-15 ... +150 psi] ²⁾						

Absolute pressure (bar [psi]) ¹⁾

0	2 [30]	4.4 [60]	11 [165]	101 [1,515]	211 [3,060]
LPPump MODULE 0 ... 0.5 bar [0 ... 7.5 psi] ²⁾					
LPSVR MODULE 0 ... 0.5 bar [0 ... 7.5 psi] ²⁾					
MPSVR MODULE 0 ... 1 bar [0 ... 15 psi] ²⁾					
HPSVR MODULE 0 ... 6 bar [0 ... 90 psi] ²⁾					
EPSVR MODULE 0 ... 11 bar [0 ... 165 psi] ²⁾					

- 1) Mixing of absolute pressure and gauge pressure sensors in a module is not possible.
 2) Smallest recommendable sensor range

For controlling absolute pressure a vacuum pump connected at the supply low port is required.

Dimensions in mm [in]

Desktop case

Front view

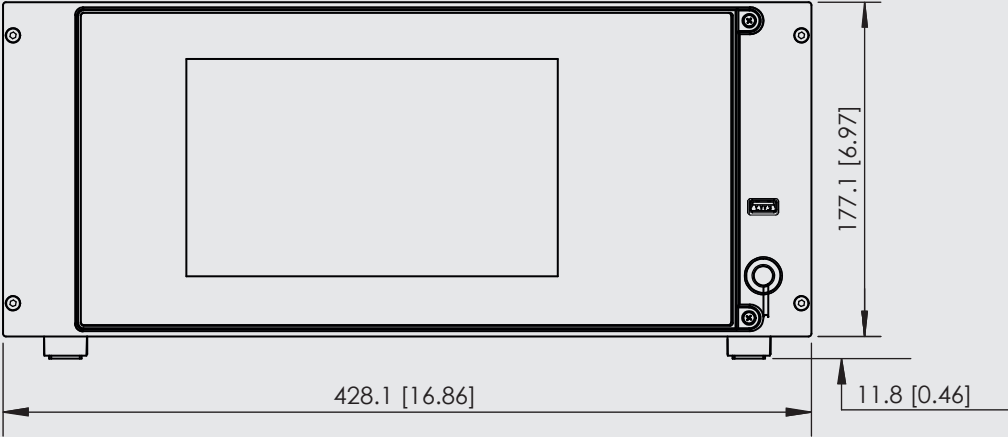

Side view (left)

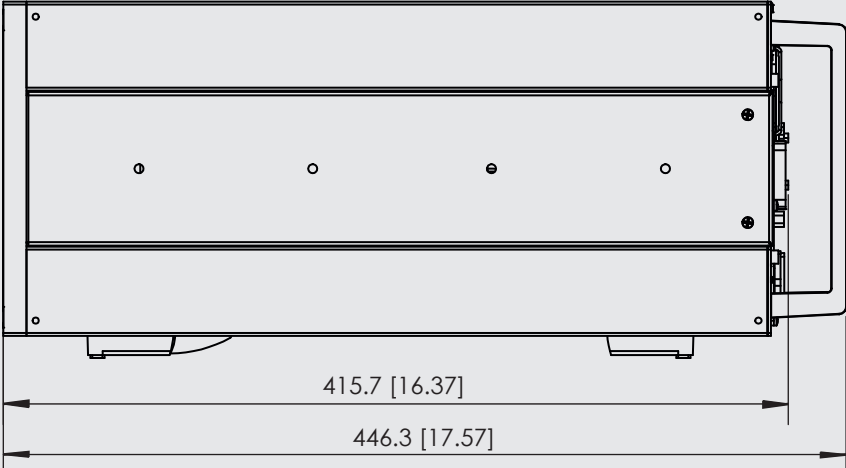

19" rack-mounting kit with side pieces, front view

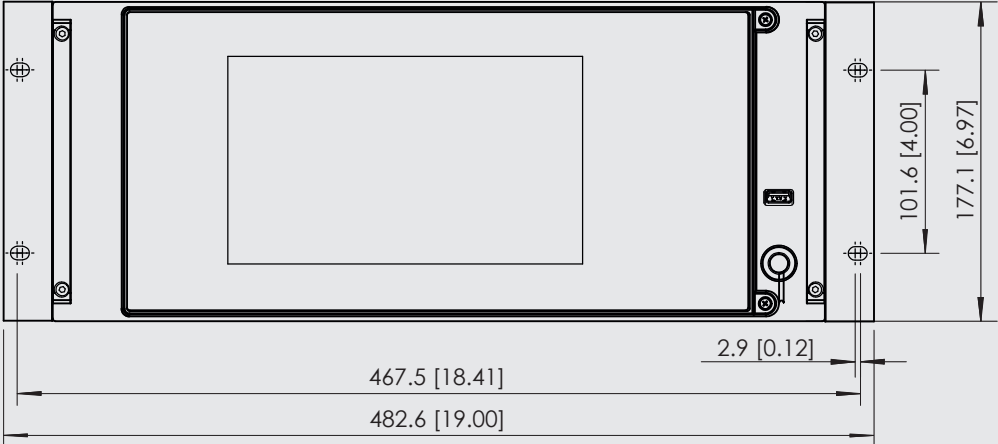

Electrical and pressure connections - rear view

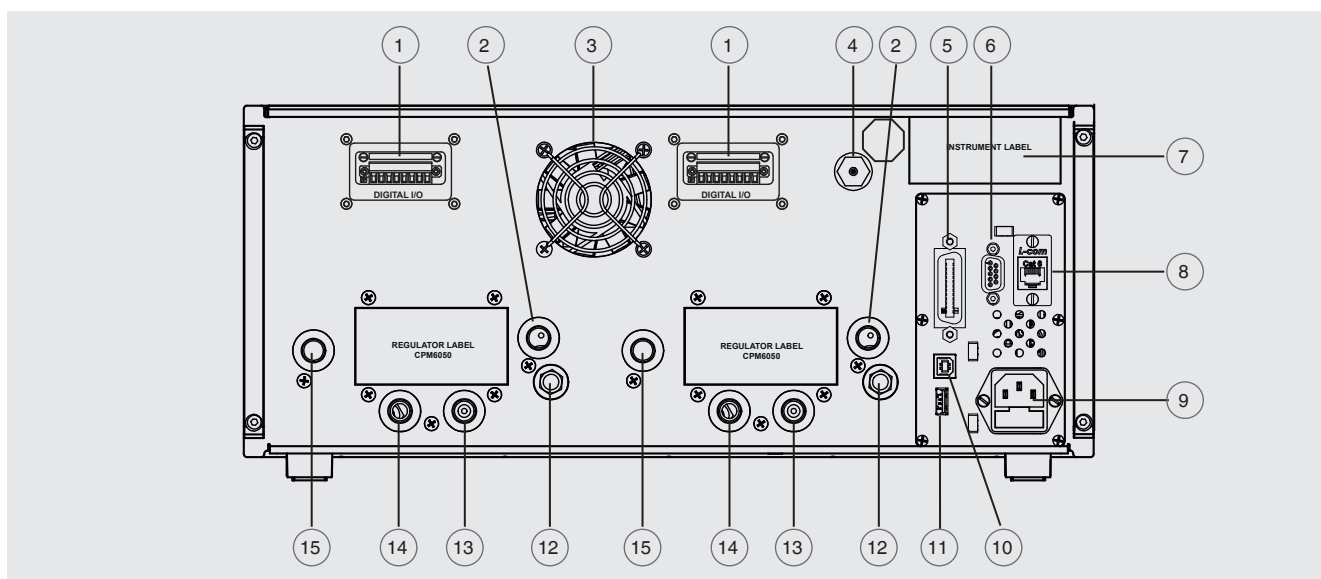

- | | |
|---|---|
| ① Digital I/O or automatic CPS connector | ⑨ Power supply |
| ② Exhaust port (7/16-20 UNF) | ⑩ USB interface (instrument) for remote communication |
| ③ Fan | ⑪ USB interface (host) for service |
| ④ Connection barometric reference (10-32 UNF) | ⑫ Vent (ATM) |
| ⑤ IEEE-488 interface | ⑬ Reference port (7/16-20 UNF) |
| ⑥ RS-232 interface | ⑭ Measure/Control port (7/16-20 UNF) |
| ⑦ Instrument label | ⑮ Supply port (7/16-20 UNF) |
| ⑧ Ethernet port | |

Modular design of the CPC6050

Up to two independent control channels

The model CPC6050 provides a high degree of flexibility by having two independent channels of operation within one instrument. This enables the user to perform two separate calibrations at the same time. The user can also perform delta function on the two channels to see the differential pressure. Each channel is equipped with its own pressure module and up to two pressure transducers.

The CPC6050 offers two different types of pressure modules, SVR module and LPPump module. The SVR modules are based on a special solenoid valve regulation technology and provide precise control over the set pressure. These are available in four different variations depending on the pressure range. The innovative low-pressure pump module (LPPump) allows pressure generation and control of very low pressures without the need of any external pressure source, thus making CPC6050 a complete solution.

Up to four pressure transducers

Each independent channel can contain up to two internal pressure transducers and utilise the instrument's removable barometric reference for pressure mode emulation. Each transducer contains its calibration, characterisation and communication functions and information. Each channel can be equipped either with two gauge or two absolute pressure transducers, thus providing the user a control range turndown of 20:1 per channel of the instrument. An optional calibration kit is available to calibrate the pressure transducers externally.

Auto-ranging capability

The model CPC6050 modular pressure controller is capable of automatically selecting the transducer within a channel depending on the user's pressure set point. The transition between transducers is automatic and seamless without any interruption in the user's application.

Extremely easy to maintain

The modular design of the CPC6050 provides easy access and quick replacement of pressure transducers. The transducers can be replaced by opening the front panel in just 30 seconds and the control channels can be replaced in less than 5 minutes. These features make the instrument very easy to service and repair with least possible downtime to the user.

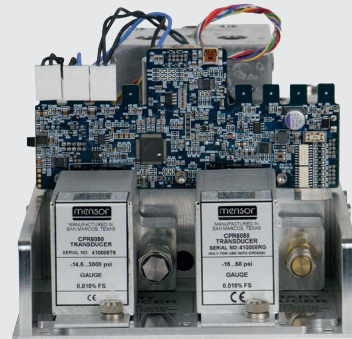

SVR pressure module equipped with up to two sensors

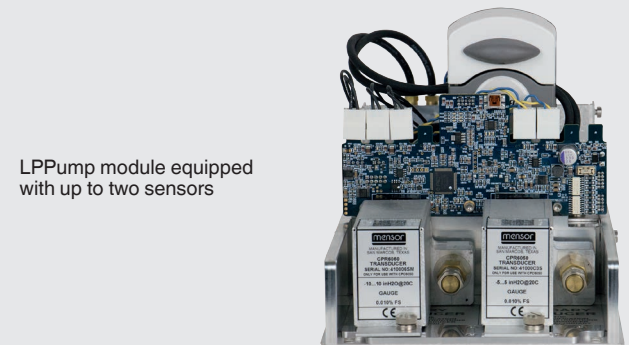

LPPump module equipped with up to two sensors



Modular design of the hardware

Easy operation via touchscreen

Shortly after power-up, the standard home screen (see following figure) is displayed. In this menu screen, one can switch between the operating modes using the buttons **MEASURE**, **CONTROL** and **VENT** at the bottom of the screen.

Standard desktop / home screen

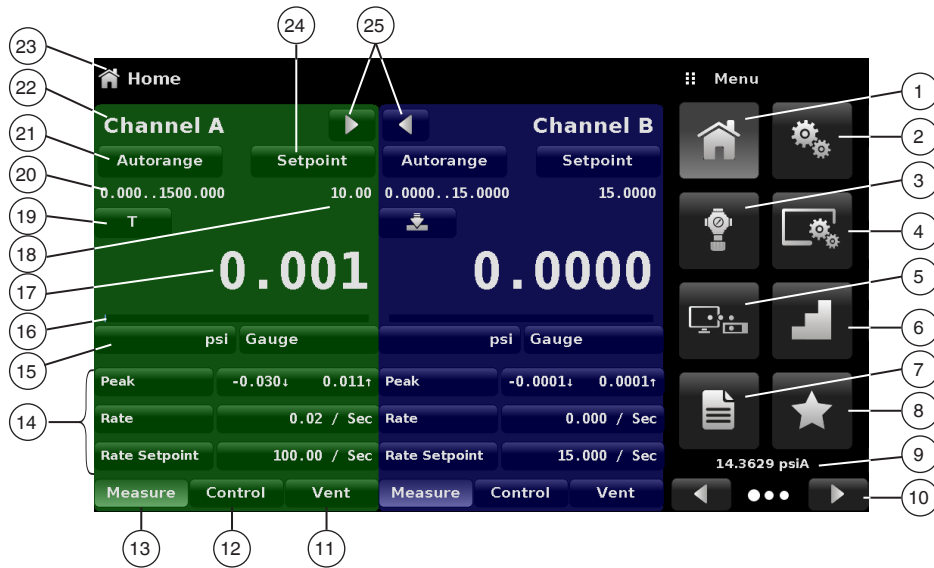

- | | |
|--|---|
| <ul style="list-style-type: none"> ① Home application ② General settings ③ Control settings ④ Display settings ⑤ Remote settings ⑥ Step settings ⑦ Sequences settings ⑧ Favourites ⑨ Barometric pressure reading (optional) ⑩ Navigation within the menu ⑪ VENT
Immediately vents the system, including the test assembly connected to the Measure/Control port, to atmosphere. ⑫ CONTROL
In control mode the instrument provides a highly accurate pressure at the Measure/Control port of the respective channel in accordance with the desired set point. | <ul style="list-style-type: none"> ⑬ MEASURE
In measure mode, the pressure present at the Measure/Control port is measured with high accuracy (if you switch directly from CONTROL to MEASURE mode, the last controlled pressure in the connected test assembly within the instrument maintained/locked, and any connected piping.). Temperature changes or external leakage may impact the pressure reading in this state. ⑭ Auxiliary displays with either uncertainty, peak, rate or alternate units ⑮ Current pressure unit and operating mode ⑯ Optional bar graph ⑰ Current measuring value ⑱ Entered set point ⑲ Zero or tare function ⑳ Pressure range of the transducers ㉑ Selection of the active transducer or auto-range ㉒ Active channel ㉓ Current application name ㉔ Set-point selection ㉕ Screen collapse/expand |
|--|---|

Additional features of the CPC6050

Leak testing

The modular pressure controller CPC6050 is capable of performing pressure leak tests on an instrument or system with a dedicated leak test menu. The menu allows the user to set dwell parameters to monitor the pressure prior to the leak detection, the maximum allowed change in pressure during the test and the pressure value at which the test is run. The leak test indicates a pass (green) or fail (red) after the test is completed.

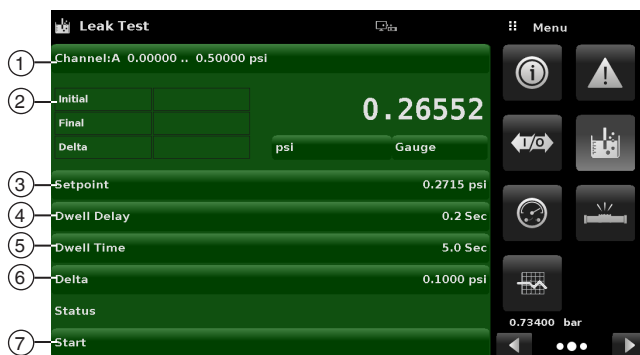

- ① Channel selection
- ② Results display
- ③ Delay prior to leak test
- ④ Time for monitoring leak

- ⑤ Maximum pressure change
- ⑥ Leak test point
- ⑦ Leak test start

Burst testing

The CPC6050 is capable of measuring and detecting pressure bursts for various applications like rupture disk testing, overpressure testing and pneumatic pipe testing. The instrument requires the user to enter pressure points slightly higher and lower than the burst pressure along with a threshold rate to detect the burst. The CPC6050 also provides a means to set the rate of pressure control both prior to and during the burst window.

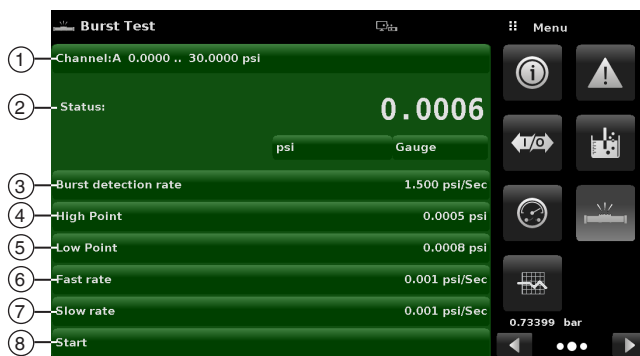

- ① Channel selection
- ② Burst test result - pass / fail
- ③ Threshold burst rate
- ④ Pressure higher than burst

- ⑤ Pressure lower than burst
- ⑥ Rate of control until low point
- ⑦ Rate of control between low and high point
- ⑧ Burst test start

Switch testing

The CPC6050 has the ability to actuate and de-actuate pressure switches using the optional digital I/O connection. The CPC6050 provides an option of connecting up to three switches per channel. The user is asked to enter a pressure range (high point and low point) between which the switch is expected to be actuated, along with the rate of pressure control prior to and during the switching window. After finishing the switch test, the pressure switching value is recorded.

- ① Channel selection
- ② Switch test results
- ③ Higher pressure than switch actuation
- ④ Lower pressure than switch actuation

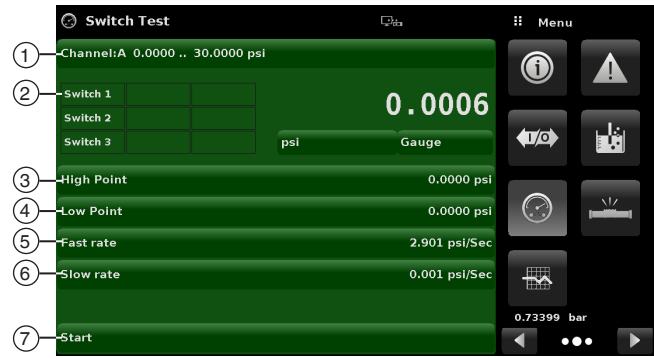

- ⑤ Rate of control until low point
- ⑥ Rate of control between low and high point
- ⑦ Switch test start

Logging application

The CPC6050 can record both remote commands as well as pressure information within the logging application. Using a USB stick, the remote feature will allow for logging of all sent/received remote commands. Additionally, the graph data logger tracks the pressure and time interval and saves the data as a CSV or txt file on the USB drive. This data can help provide quick troubleshooting assistance to keep the CPC6050 running smoothly.

- ① Start remote logging
- ② Select graph data channel
- ③ Time interval for recording

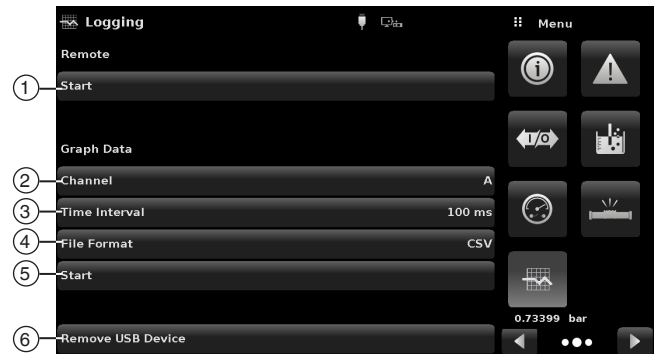

- ④ Graph file format selection
- ⑤ Start graph data logging
- ⑥ Remove USB device

Versatility with single output and single supply

Auto-channeling with single output

The modular pressure controller CPC6050 is available as a single-output auto-range option. The single-output option allows the user to access the two channels of the instrument together as a single channel. The transition between the two channels and their internal transducers is automatic and provides the user a stable control over a wide dynamic pressure range.

The maximum control range turndown is as high as 400:1 between the full scale value of the lowest and highest transducer. When configured with four transducers that have contiguous ranges, the single-output auto-range option of the CPC6050 can calibrate an instrument over a wide range with the highest possible accuracy and test uncertainty ratio.

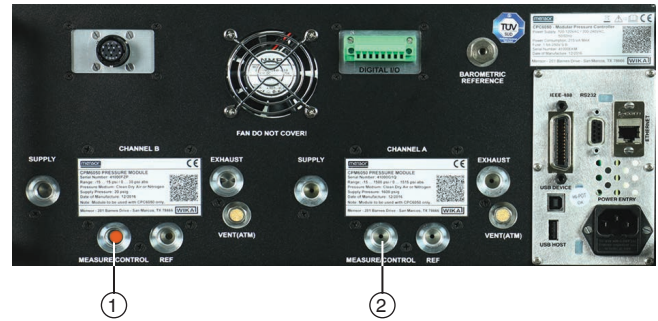

Auto-channeling with single output

2-channel version with single output

The single-output / dual-channel option allows the user to select either channel A or channel B as the active channel at any point during operation. This provides the unique ability to choose different pressure types between the channels, or a significant difference in pressure range between the two without significant change in the instrument setup. The pressure output to the channels is combined and the same pressure output can be accessed when using either of the two channels. This reduces the total setup time and costs for manifold connections.

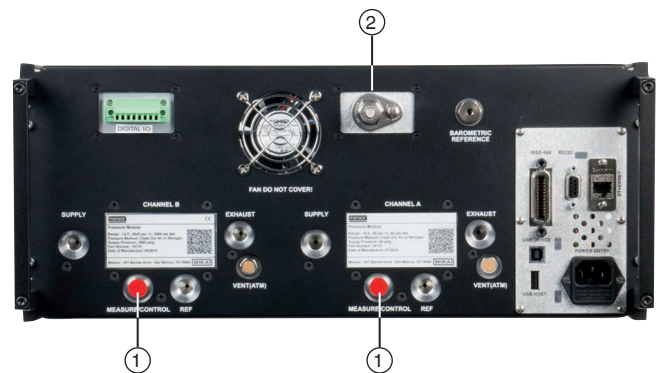

2-channel version with single output

Single supply to both channels

The CPC6050 can be customised to have a single pressure supply to source both channels. The single supply option reduces the different pressure supply requirements and reduces the setup costs and resources needed. The single pressure supply is connected to the supply port of channel A and should be adequate to support the pressure supply requirements of the highest reference pressure transducer installed.

The instrument internally reduces this pressure supply to sustain the pressure on channel B as well. The single supply option can be configured with a standard 2-channel instrument or an auto-ranging single-output instrument.

- ① Plugged port, inactive
- ② Single measure/control output

Automatic contamination prevention system (A-CPS)

Specifications

Model A-CPS	
Operating conditions	
Maximum operating pressure	211 bar abs. [3,065 psi abs.]
Maximum operating temperature	80 °C [176 °F]
Voltage supply	
Power supply	DC 12 V
Power consumption	13 VA
Pressure connection	
To the Measure/Control port of CPC6050	1 port with ¼" tube adapted to 7/16" - 20 F SAE
To the test item	2 ports: <ul style="list-style-type: none"> ■ 7/16" - 20 F SAE ■ 6 mm tube fitting ■ ¼" tube fitting ■ ¼ NPT, female thread ■ ⅜ NPT, female thread ■ ⅜ BSP, female thread
Dimensions	
Dimensions (W x H x D)	139.7 x 266.7 x 139.7 mm [5.5 x 10.5 x 5.5 in]
Weight	3.9 kg [8.8 lb]

Dimensions in mm [in]

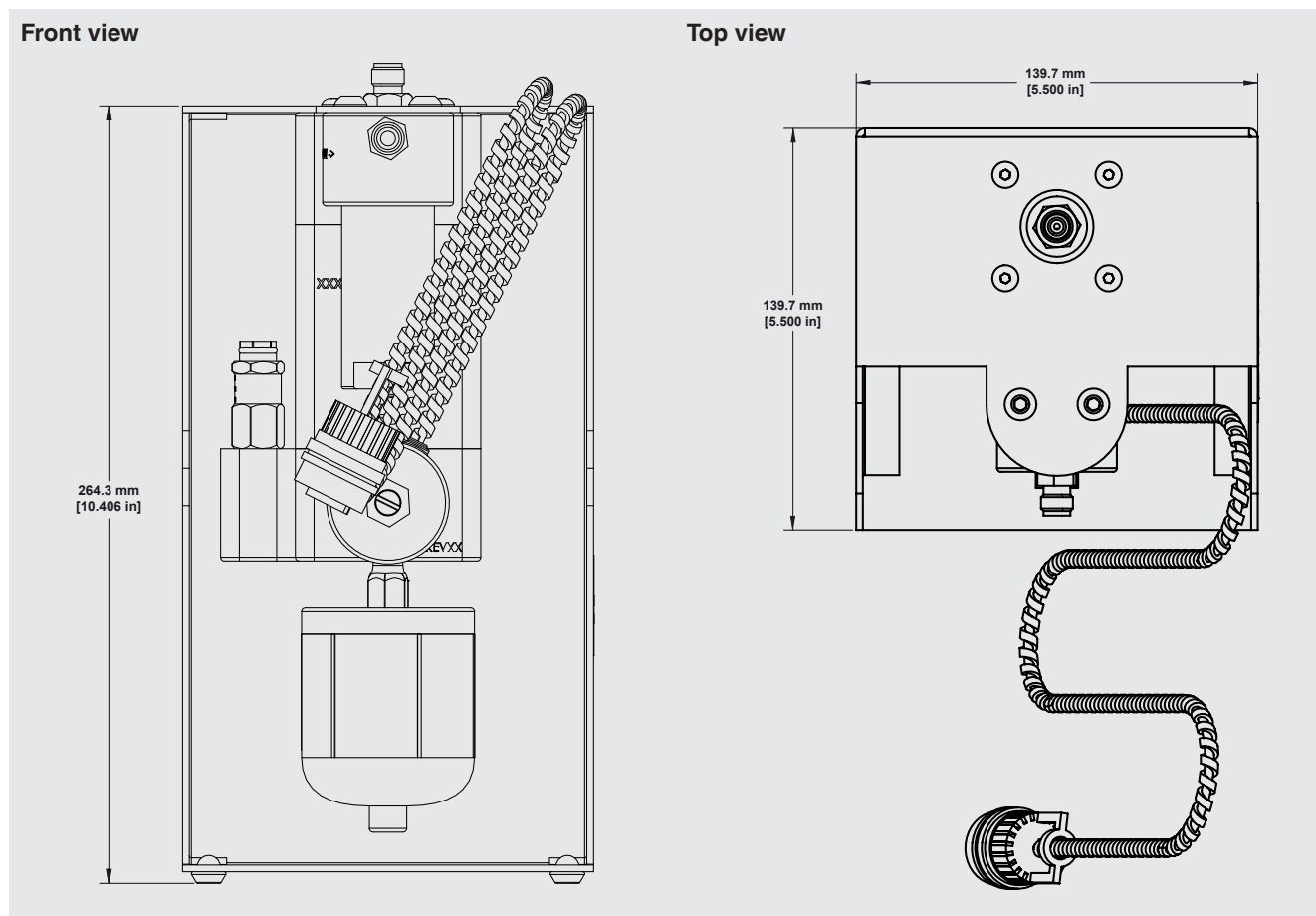

Side view (right)

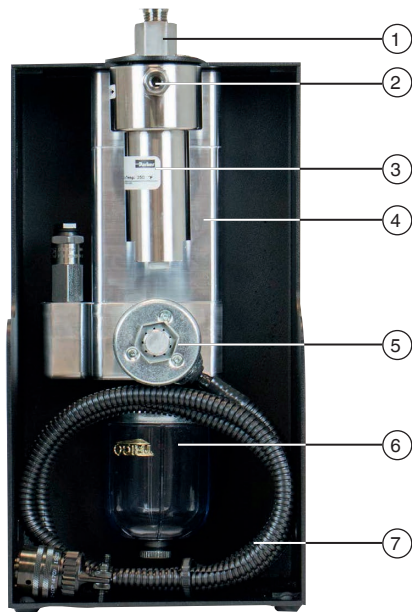
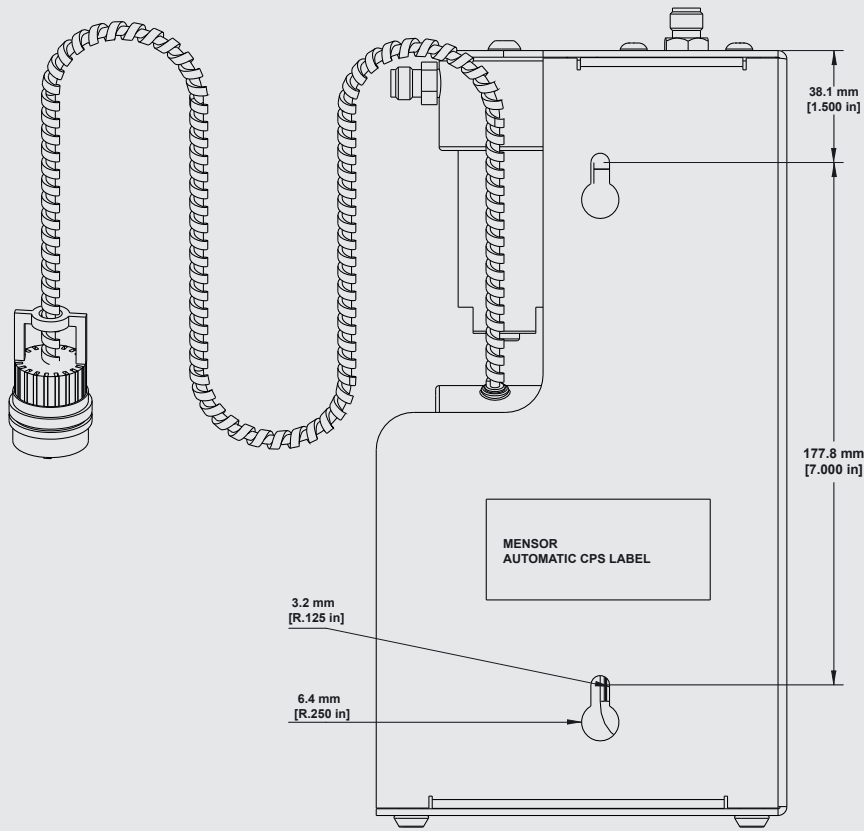

- ① Top mount test item connection
- ② Connection to the Measure/Control port of the CPC6050
- ③ Integrated liquid trap
- ④ Integrated coalescing filter
- ⑤ Purge actuation valve
- ⑥ Sump collection bottle
- ⑦ Connection to the A-CPS backplate of the CPC6050

Automatic contamination prevention system (A-CPS)

Active decontamination

The **Automatic Contamination Prevention System**, or A-CPS, is an accessory to the CPC6050 modular pressure controller that prevents particles, water or oil contaminants from entering the instrument through the test item. The A-CPS primarily uses a liquid trap and an automatically actuated bleed valve to remove all fluid contaminants and then stores them in a transparent sump bottle for easy cleanup. It also has a coalescing filter to remove any particle contaminants left in the pneumatic media before it enters the pressure controller.

The A-CPS allows hassle-free operation between the test item and the CPC6050 by reducing the additional process of deep cleaning the instrument prior to calibration. The A-CPS does not require an additional power source because it is controlled completely by the pressure controller itself.

The A-CPS also acts like a test gauge stand for easy mounting and setup of the test item. This reduces the requirement of additional manifolds and setup.

A-CPS operation

Automatic or manual purging with CPC6050

The **Automatic Contamination Prevention System** can be driven seamlessly with any channel on the CPC6050 in manual or auto mode. The auto mode will engage the purge sequence every time the controller switches from vent to control mode.

The manual mode provides an option for pre-cleansing the system by purging the test item several times. A purge button appears on the instrument's home screen when the A-CPS is activated. The purge button enables setting the desired maximum pressure for decontaminating the test item prior to normal operation with the model CPC6050 modular pressure controller.

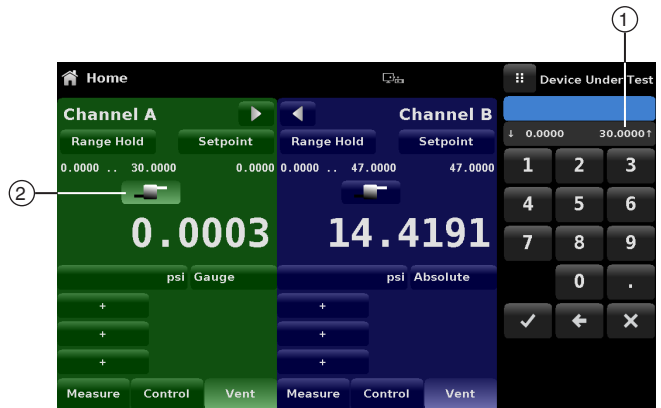

- ① Purge button
- ② Max. purge pressure limit

WIKA-Cal calibration software

Easy and fast creation of a high-quality calibration certificate

The WIKA-Cal calibration software is used for generating calibration certificates or logger protocols for pressure measuring instruments and is available as a demo version for a cost-free download.

To switch from the demo version to a licensed version, a USB dongle with a valid licence must be purchased.

The preinstalled demo version changes automatically to the selected version when plugging in the USB dongle and remains available as long as the USB dongle is connected to the PC.



- The user is guided through the calibration or logger process
- Management of calibration data and instrument data
- Intelligent preselection via SQL database
- Menu languages: German, English, Italian, French, Dutch, Polish, Portuguese, Romanian, Spanish, Swedish, Russian, Greek, Japanese, Chinese
More languages are due with software updates
- Customer-specific complete solutions possible
- Maximum degree of automation in connection with our CPC series

The supported instruments are continuously expanded and even customer-specific adaptations are possible.

→ For further information, see data sheet CT 95.10



Three WIKA-Cal licences are available together with one CPC series pressure controller

The WIKA-Cal calibration software is available for online calibrations together with a PC. The scope of software functions depends on the selected licence.

Several licences can be combined on one USB dongle.

Cal-Template (demo version)	Cal-Template (light version)	Cal-Template (full version)	Log-Template (full version)
Fully automatic calibration	Semi-automatic calibration	Fully automatic calibration	<ul style="list-style-type: none"> ■ Live measured value recording for a certain period of time with selectable interval, duration and start time ■ Creation of logger protocols with graphic and/or tabular representation of the measuring results in PDF format ■ Possibility of exporting measuring results as CSV file
Limitation to two measuring points	No limitation of the measuring points approached		
<ul style="list-style-type: none"> ■ Creation of 3.1 inspection certificates per DIN EN 10204 ■ Calibration data can be exported to Excel® template or XML file ■ Calibration of pressure measuring instruments 			
Ordering information for your enquiry for a single licence:			
Is available for a cost-free download	WIKA-CAL-LZ-Z-Z	WIKA-CAL-CZ-Z-Z	WIKA-CAL-ZZ-L-Z
Ordering information for your enquiry for a pair licence:			
Cal-Template (light version) together with Log-Template (full version)			WIKA-CAL-LZ-L-Z
Cal-Template (full version) together with Log-Template (full version)			WIKA-CAL-CZ-L-Z

Accessories for CPC6050 1)		Order code
Description		CPX-A-C5
-	<p>19" built-in case With side pieces, NAM</p> <p>With side pieces, EU</p>	-U- -T-
	<p>Barometric reference Measuring range: 8 ... 17 psi abs. Accuracy to 0.01 % of reading</p> <p>Measuring range: 552 ... 1,172 mbar abs. Accuracy to 0.01 % of reading</p> <p>Measuring range: 552 ... 1,172 hPa abs. Accuracy to 0.01 % of reading</p>	-3- -K- -L-
	<p>Calibration adapter For reference pressure sensor, voltage supply and software</p>	-4-
	<p>Calibration adapter For barometric reference, voltage supply and software</p>	-5-
	<p>Transport case</p>	-6-
	<p>Adapter set Consisting of: 4 adapters with 1/8 BSPG, female thread Material: brass</p>	-B-
	<p>Adapter set Consisting of: 4 adapters with 1/4" tube fitting Material: brass</p>	-I-
	<p>Adapter set Consisting of: 4 adapters with 6 mm Swagelok® male thread Material: brass</p>	-M-
	<p>Adapter set Consisting of: 4 adapters with 1/4 NPT, female thread Material: brass</p>	-N-
	<p>Adapter set Consisting of: 4 adapters with 1/8 NPT, female thread Material: brass</p>	-S-
	<p>Block and bleed valve Pressure range: ≤ 400 bar [6,000 psi]</p>	-8-
	<p>Coalescing filter Pressure range: ≤ 240 bar [3,600 psi]</p>	-9-

Accessories for CPC6050 1)		Order code
Description		CPX-A-C5
	Automatic contamination protection (A-CPS) Pressure range: ≤ 100 bar [1,500 psi]	-A-
	Pressure range: ≤ 210 bar [3,045 psi]	-O-
Replacement filters for automatic CPS		-2-
	Vacuum regulator for low-pressure ranges	-1-
Ordering information for your enquiry:		
1. Order code: CPX-A-C5 2. Option:		↓ []

1) The figures are an example and may change depending on the state-of-the-art in design, material composition and representation.

Scope of delivery

- Pressure controller, modular version, model CPC6050 (desktop case)
- 1.5 m [5 ft] power cord
- Operating instructions
- Calibration certificate

Options

- Spare reference pressure transducer model CPR6050
- Spare pressure module model CPM6050
- Customer-specific system
- Digital I/O
- Single output / auto-range or 2-channel version
- Single pressure supply for both channels

Ordering information

CPC6050 / Case type / Channel A: Pressure controller module / Channel B: Pressure controller module / Barometric reference / Type of certificate for barometric reference / Single output for 2-channel versions / CPC supply / Channel A back plate / Channel B back plate / Power cord / Transport case / Further approvals / Additional ordering information

CPR6050 / Mounted in CPC6050 / Pressure unit / Pressure type / Minimum pressure range / Maximum pressure range / Accuracy / Type of certificate / Further approvals / Additional ordering information

CPM6050 / Mounted in CPC6050 / Work pressure for pressure controller module / Reference pressure sensor 1 / Reference pressure sensor 2 / Vacuum regulator / Pressure connection adapter / Additional ordering information

© 10/2015 WIKA Alexander Wiegand SE & Co. KG, all rights reserved.
The specifications given in this document represent the state of engineering at the time of publishing.
We reserve the right to make modifications to the specifications and materials.
In case of a different interpretation of the translated and the English data sheet, the English wording shall prevail.

