

Pressure Transmitter with field case Model F-20, standard version Model F-21, flush diaphragm

WIKA Data Sheet PE 81.19

Applications

- Chemical industry
- Food and Beverage
- Pharmaceutical industry
- Rough environments
- Mechanical engineering

Special Features

- Pressure ranges from 0 ... 0.1 bar to **0 ... 25 bar**
- All important standard signal outputs
- Compact size and robust construction
- All stainless steel design
- Optimal electrical connection

Description

Sturdy and compact

Due to its special design, this field case pressure transmitter can be used in the most aggregating environments. As it does not have any rough surfaces, it is ideally suited for use in the food and allied industries as well as in the pharmaceutical market.

Comfortable electrical connection

The sophisticated design of this pressure transmitter renders electrical connection very easy. It is realised by the chamfered design of the instrument's head as well as the internal spring clip terminals, which provide easy access. The requested cable length can be customised on site.

Variable Structure

The all stainless steel case complies with IP 67. All wetted parts are made of stainless steel and are hermetically welded. Therefore there is no need for additional sealing material, which could possibly react with the pressure medium.



Fig. left Pressure transmitter F-20, standard version
Fig. right Pressure transmitter F-21, flush diaphragm

The high variety of pressure connections enables use in a wide range of applications.

The encapsulated electronics and the small construction size of the transmitter offer optimal protection from shock and vibration.

The transmitters with output signal 4 ... 20 mA provide a test circuit connection, which makes it possible to check the measuring circuit free of interruptions.

The model F-21 with flush diaphragm is particularly suitable for the measurement of viscous fluids or media containing particulates that may clog the pressure connection of standard industrial transmitters.

Specifications

Model F-20 / F-21

| | | | | | | | | | | | | | | |
|--|---|---|------|------|-----|-----|---|-----|-----|----|----|----|----|-----------------------------|
| Pressure ranges | bar | 0.1 | 0.16 | 0.25 | 0.4 | 0.6 | 1 | 1.6 | 2.5 | 4 | 6 | 10 | 16 | 25 |
| Over pressure safety | bar | 1 | 1.5 | 2 | 2 | 4 | 5 | 10 | 10 | 17 | 35 | 35 | 80 | 50 |
| | | {Vacuum, gauge pressure, compound range, absolute pressure are available} | | | | | | | | | | | | |
| Materials | (other materials see WIKA diaphragm seal program) | | | | | | | | | | | | | |
| ■ Wetted parts | | | | | | | | | | | | | | |
| - Model F-20 | Stainless steel | | | | | | | | | | | | | |
| - Model F-21 | Stainless steel O-ring: NBR {FPM/FKM} | | | | | | | | | | | | | |
| ■ Case | Stainless steel | | | | | | | | | | | | | |
| ■ Electrical connection | With internal spring clip terminal; cross section max. 2.5 mm ² , ground terminals, internal for brass nickel-plated and {stainless steel} and {stainless steel conduit} threaded connection | | | | | | | | | | | | | |
| ■ Internal transmission fluid | Synthetic oil | | | | | | | | | | | | | |
| Power supply U ₊ | DC | 11 ... 30 V (14 ... 30 V with signal output 0 ... 10 V) | | | | | | | | | | | | |
| Signal output and maximum ohmic load R _A | R _A in Ohm | 4 ... 20 mA, 2-wire R _A ≤ (U _B - 10 V) / 0.02 A 0 ... 10 V, 3-wire R _A > 10 k | | | | | | | | | | | | |
| Test circuit signal / max. load R _A | Only for instruments with 4 ... 20 mA signal output. R _A < 15 Ohm with 20 mA | | | | | | | | | | | | | |
| Adjustability zero/span | % | ± 5 using potentiometers inside the instrument | | | | | | | | | | | | |
| Response time (10 ... 90 %) | ms | ≤ 1 ¹⁾ | | | | | | | | | | | | |
| Insulation voltage | DC | 500 V | | | | | | | | | | | | |
| Accuracy ²⁾ | % of span | ≤ 0.5 ≤ {0.25} for measuring ranges ≥ 0.25 bar | | | | | | | | | | | | |
| Non-linearity | % of span | ≤ 0.2 (BFSL) according to IEC 61298-2 | | | | | | | | | | | | |
| Non-repeatability | % of span | ≤ 0.1 | | | | | | | | | | | | |
| 1-year stability | % of span | ≤ 0.2 (at reference conditions) | | | | | | | | | | | | |
| Permissible temperature of | | | | | | | | | | | | | | |
| ■ Medium | -30 ... +100 °C {-40 ... +125 °C} ¹⁾ | | | | | | | | | | | | | |
| ■ Ambience | -20 ... +80 °C {-30 ... +105 °C} | | | | | | | | | | | | | |
| ■ Storage | -40 ... +100 °C | | | | | | | | | | | | | |
| Compensated temp. range | 0 ... +80 °C | | | | | | | | | | | | | |
| Temperature coefficients within compensated temp range | | | | | | | | | | | | | | |
| ■ Mean TC of zero | % of span | ≤ 0.2 / 10 K (< 0.4 for pressure range ≤ 0.25 bar) | | | | | | | | | | | | |
| ■ Mean TC of range | % of span | ≤ 0.2 / 10 K | | | | | | | | | | | | |
| CE-conformity | <ul style="list-style-type: none"> ■ Pressure equipment directive ■ EMC directive ³⁾ EN 61326 emission (group 1, class B) and immunity (industrial environments) ■ RoHS directive | | | | | | | | | | | | | |
| Shock resistance | g | 600 according to IEC 60068-2-27 | | | | | | | | | | | | (mechanical shock) |
| Vibration resistance | g | 10 according to IEC 60068-2-6 | | | | | | | | | | | | (vibration under resonance) |
| Wiring protection | | | | | | | | | | | | | | |
| ■ Overvoltage protection | DC | 36 V | | | | | | | | | | | | |
| ■ Short-circuit proofness | Sig+ towards UB- | | | | | | | | | | | | | |
| ■ Reverse polarity protection | UB+ towards UB- | | | | | | | | | | | | | |
| Weight | kg | Approx. 0.35 | | | | | | | | | | | | |

{ } Items in curved brackets are optional extras for additional price

1) Response time: ≤10 ms at medium temperatures below <-30 °C

2) Including non-linearity, hysteresis, zero point and full scale error (corresponds to error of measurement per IEC 61298-2). Calibrated in vertical mounting position with process connection facing downwards.

3) The existence of strong electromagnetic fields in a frequency range of < 2.7 GHz can result in increased measured errors up to 1 % of span. Do not install the instruments in the vicinity of strong electromagnetic sources of interference (e.g. transmitting device, radio equipment), or use sheath current filters where applicable.

Dimensions in mm

Electrical connections

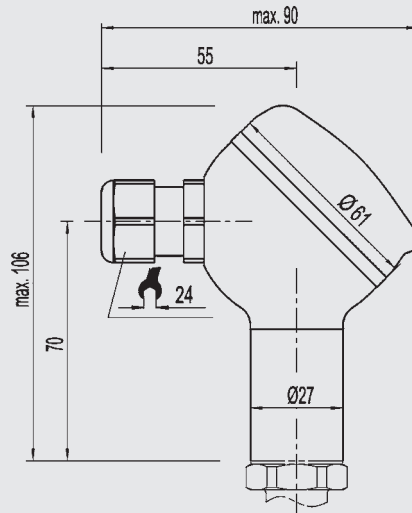

Pressure connections F-20

G 1/2
EN 837

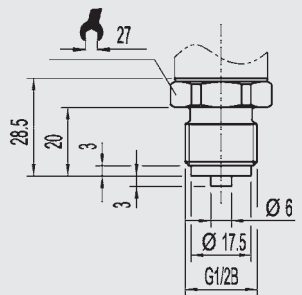

G 1/4
EN 837

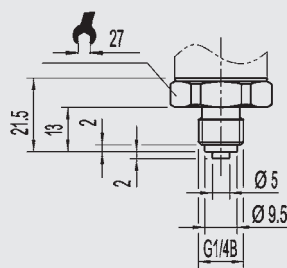

1/4 NPT
per „Nominal size for US
standard tapered pipe
thread NPT“

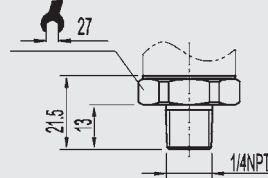

1/2 NPT
per „Nominal size for US
standard tapered
pipe thread NPT“

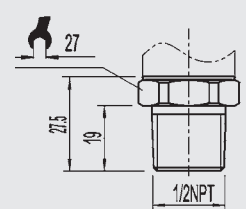

Others on request

Pressure connections F-21

G 1/2 B
0 ... 2.5 bis 0 ... 600 bar

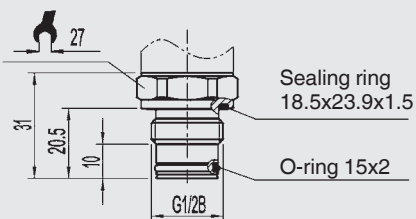

G 1B
0 ... 0.1 bis 0 ... 1.6 bar

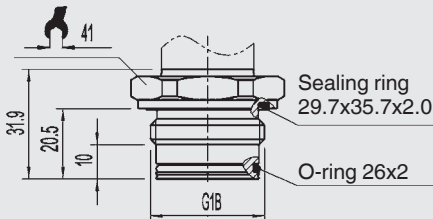

For installation and safety instructions see the operating instructions for this product.

For tapped holes and welding sockets please see Technical Information IN 00.14 for download at www.wika.de

Wiring details

| | | | | | |
|-----------------------------------|---|--------|-----------|------------|------------|
| | Field case (with internal spring clip terminals) | | | | |
| |  | | | | |
| 2-wire | UB = 1 | 0V = 2 | Test+ = 3 | Test- = 4 | screen = 5 |
| 3-wire | UB = 1 | 0V = 2 | Sig+ = 3 | screen = 5 | |
| Wire gauge | 7-13 mm | | | | |
| Ingress protection per IEC 60 529 | IP 67 | | | | |
| | The ingress protection classes specified only apply while the pressure transmitter is connected with female connectors that provide the corresponding ingress protection. | | | | |

Further information

You can obtain further information (data sheets, instructions, etc.) via our internet address www.wika.de

Specifications and dimensions given in this leaflet represent the state of engineering at the time of printing. Modifications may take place and materials specified may be replaced by others without prior notice.



WIKAI Alexander Wiegand GmbH & Co. KG
 Alexander-Wiegand-Straße 30
 63911 Klingenberg/Germany
 Tel. +49 / (0) 9372/132-0
 Fax +49 / (0) 9372/132-406
 E-mail info@wika.de
www.wika.de